

5.– 8. September 2011  
in Nürnberg



# Herbstcampus

Wissenstransfer  
par excellence

## Effiziente Integration von Anwendungen mit Apache Camel

Die smarteste Versuchung ...

Kai Wähler

MaibornWolff et al GmbH

Martin Huber

innoQ GmbH



**Nur wenige Folien...**

# ... dafür jede Menge Live-Demos !!!





## Wachstum

- Anwendungen
- Schnittstellen
- Technologien
- Produkte



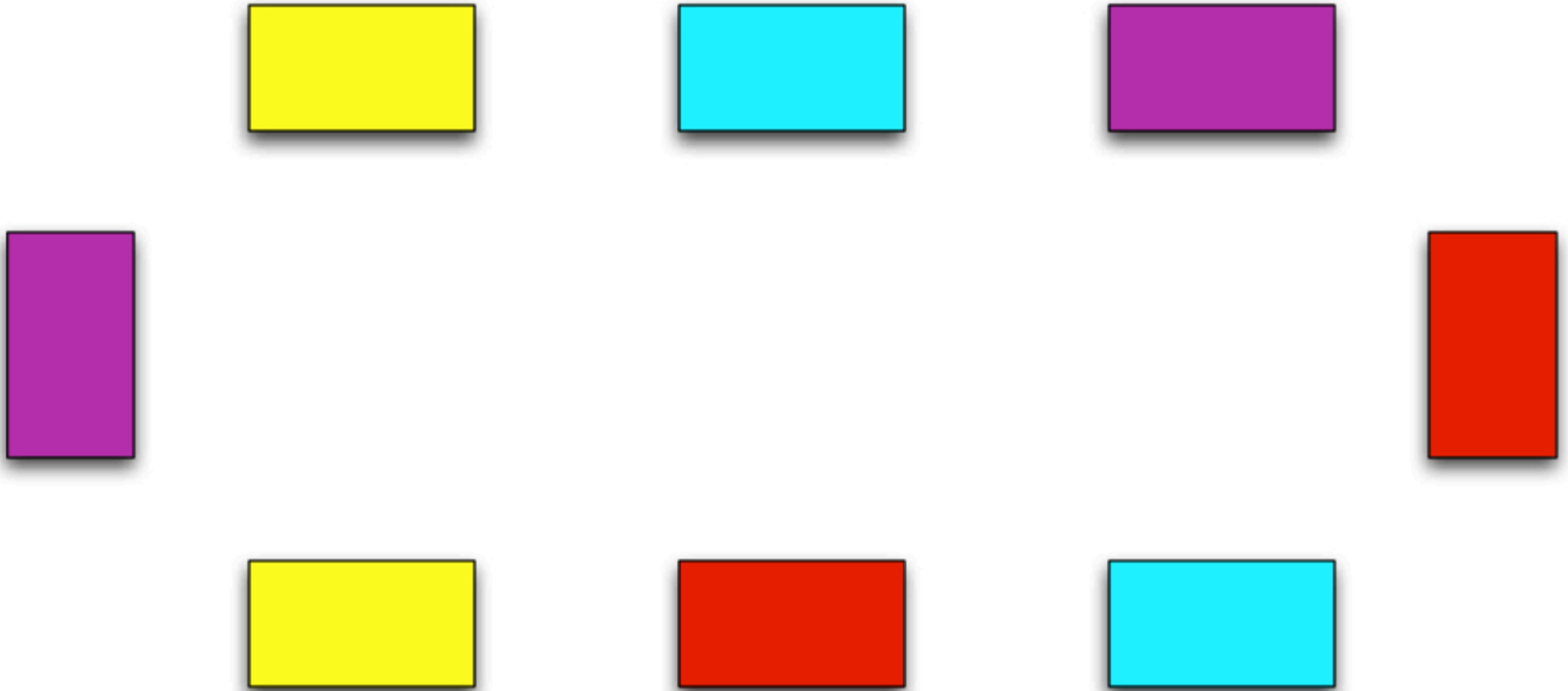

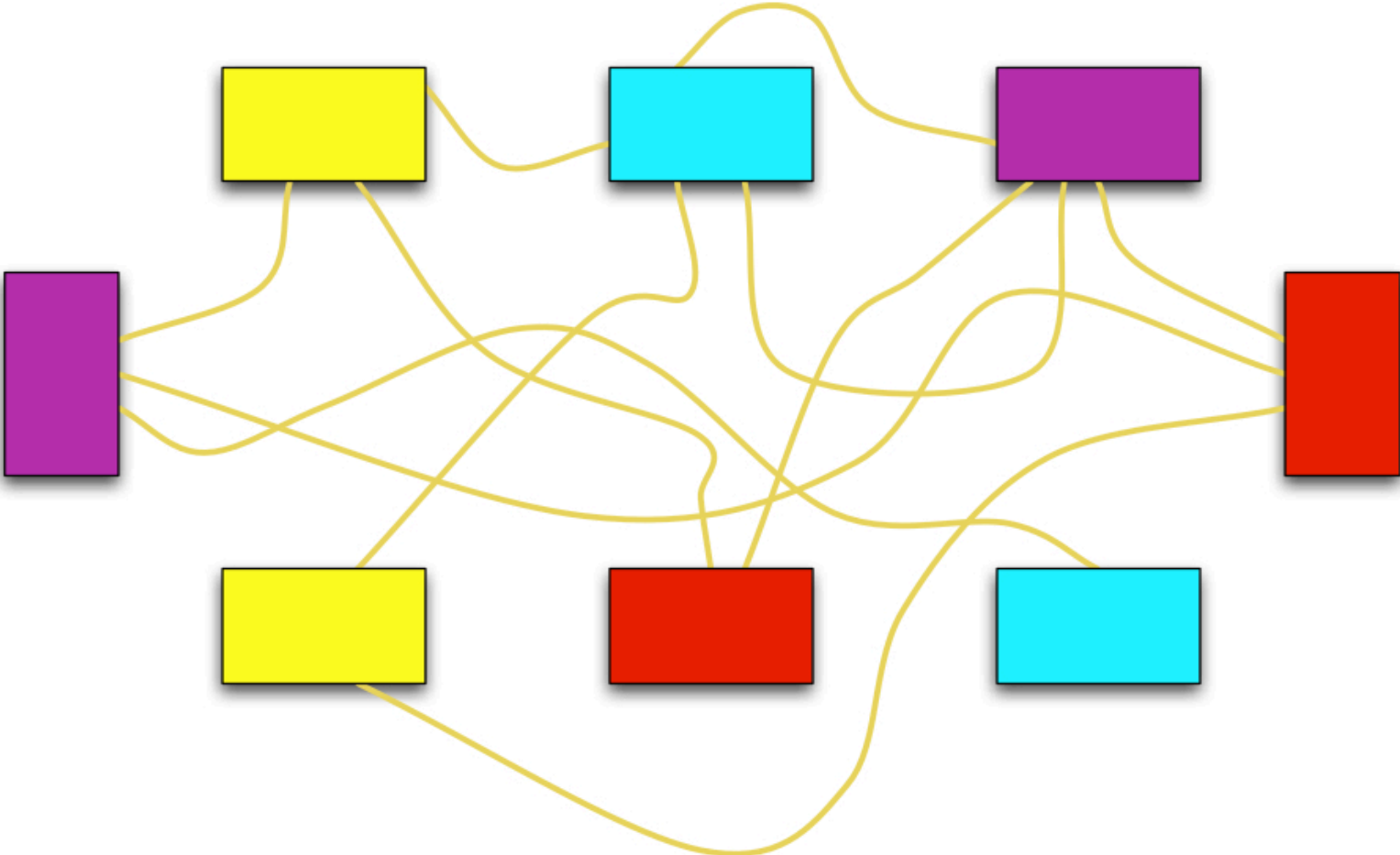

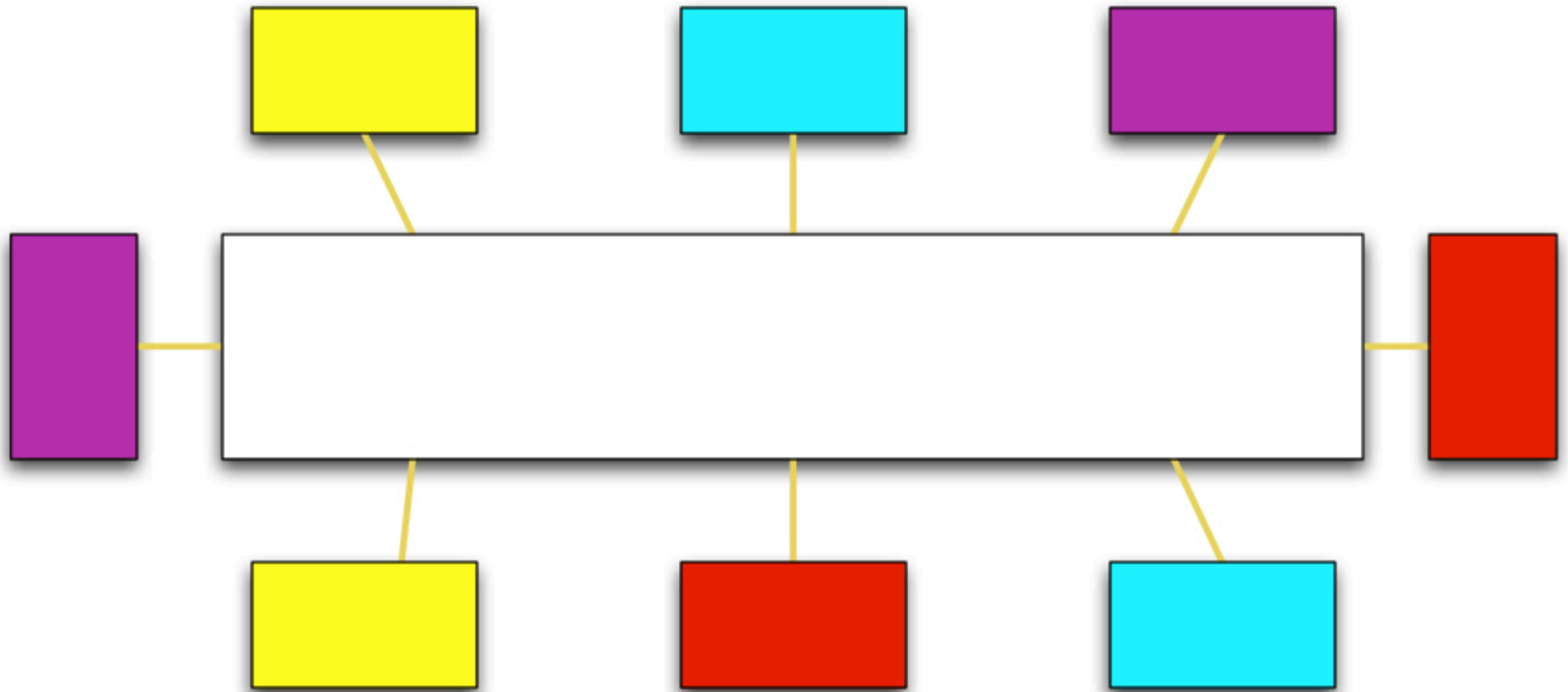



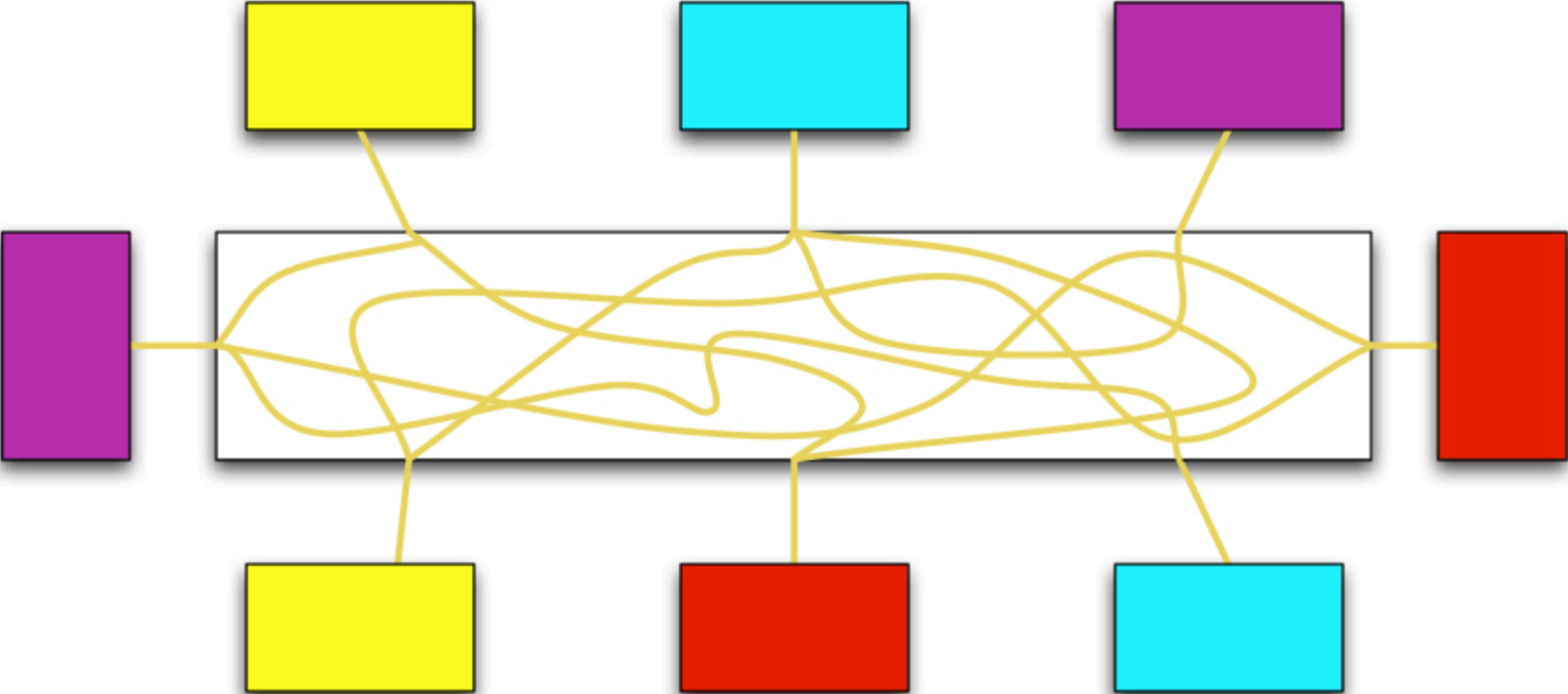

Wie liest man den Inhalt einer Datei aus?

```
try {  
  BufferedReader in = new BufferedReader(new  
  FileReader("infilename")); String str;  
  while ((str = in.readLine()) != null) { process(str); }  
  in.close(); }  
catch (IOException e) { }
```



Viele Wege führen nach Rom...



- Standardisiert modellieren
- Effizient umsetzen
- Automatisiert testen



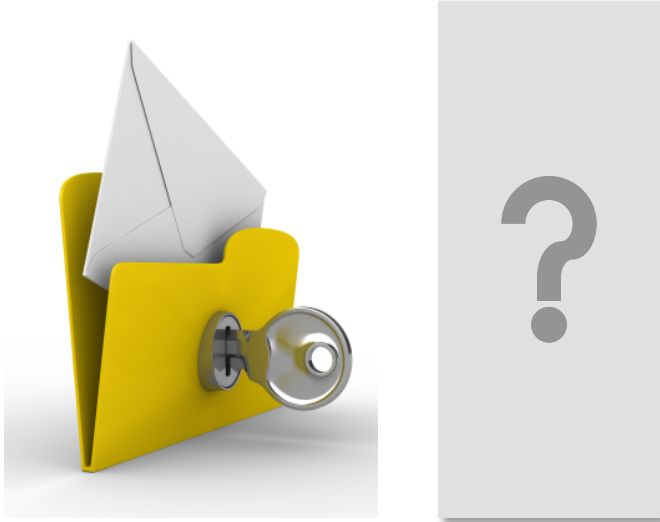

**Enterprise Integration Patterns verstehen!**

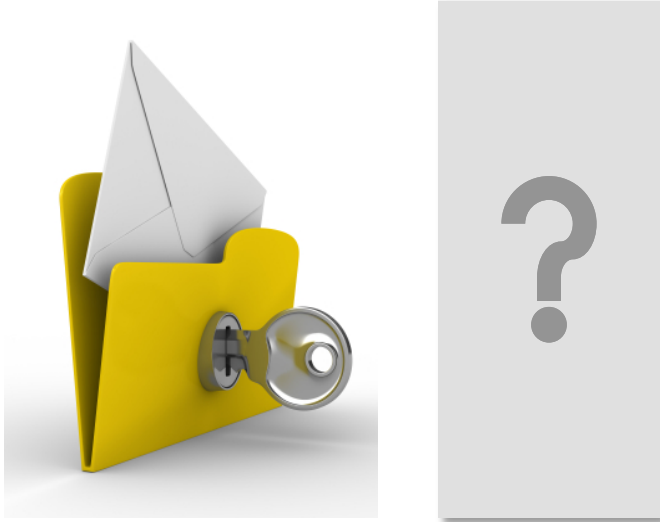

Enterprise Integration Patterns verstehen!

**Das Konzept von Apache Camel verstehen!**

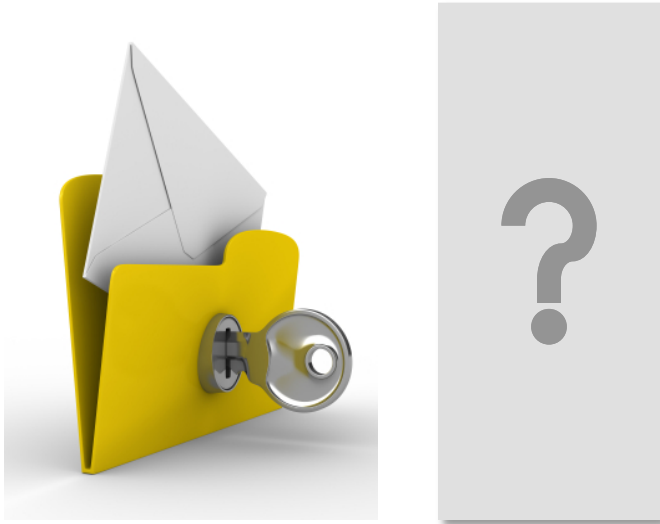

Enterprise Integration Patterns verstehen!

Das Konzept von Apache Camel verstehen!

**Apache Camel an Hand des Live-Demos kennenlernen!**

1) Was sind Enterprise Integration Patterns?

2) Was ist Apache Camel?

3) Anwendungsfall für das Live-Demo

**4) LIVE DEMO: Apache Camel**

5) Ausblick



1) Was sind Enterprise Integration Patterns?

2) Was ist Apache Camel?

3) Anwendungsfall für das Live-Demo

4) LIVE DEMO: Apache Camel

5) Ausblick

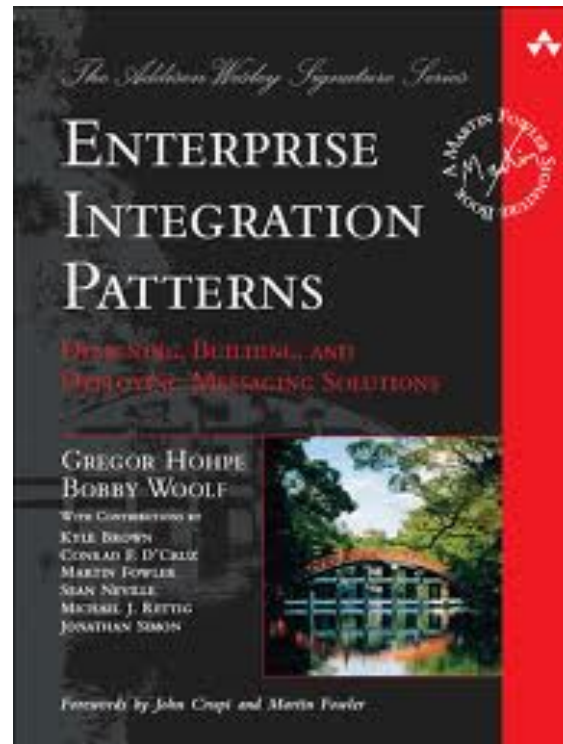

## File Transfer



## Shared Database

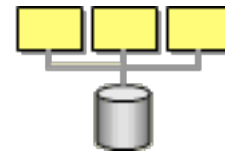

## Remote Procedure Invocation



## Messaging

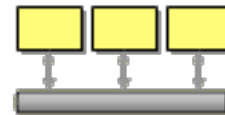

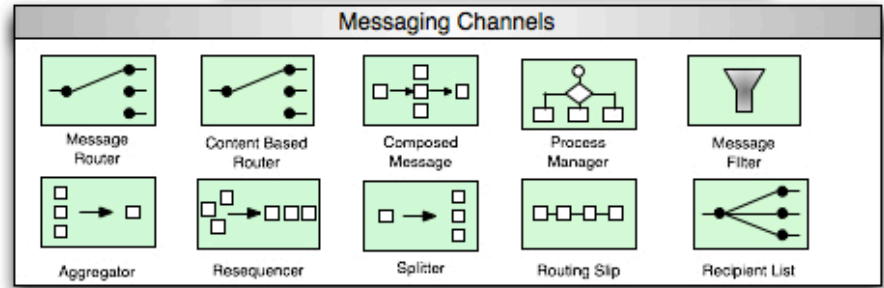
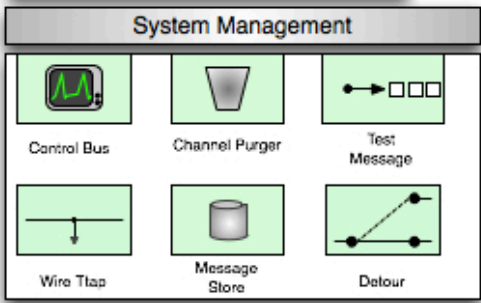
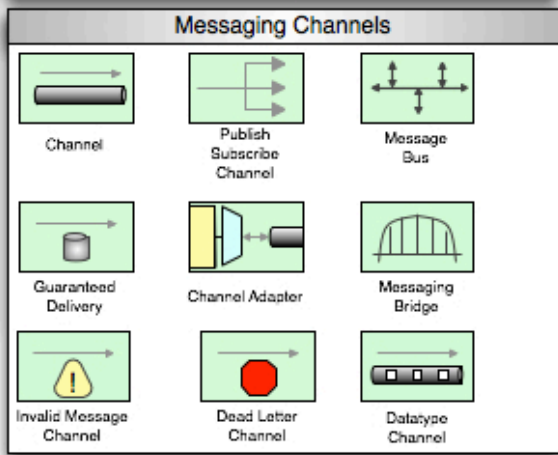
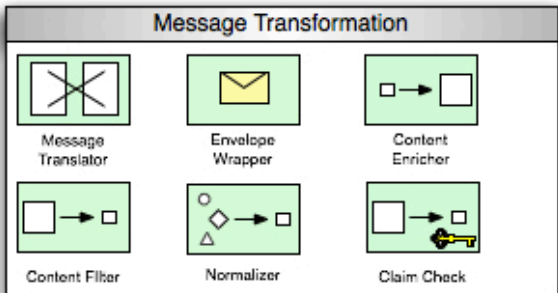
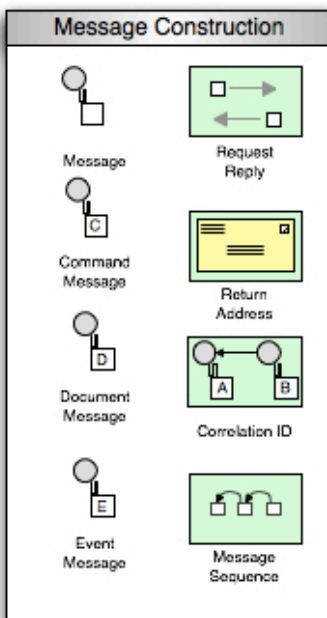
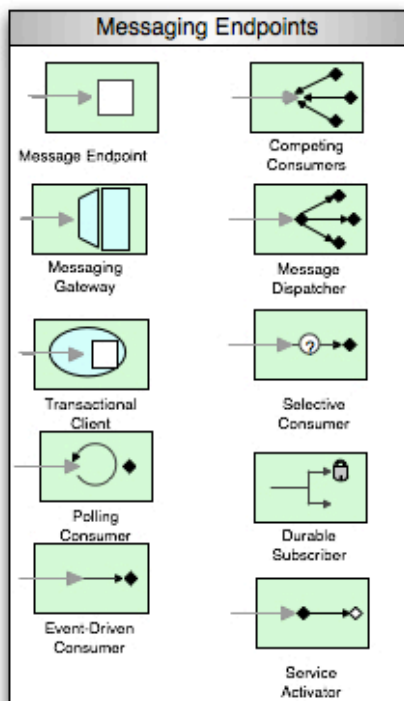

1) Was sind Enterprise Integration Patterns?

2) Was ist Apache Camel?

3) Anwendungsfall für das Live-Demo

4) LIVE DEMO: Apache Camel

5) Ausblick

# Implementiert die EIPs

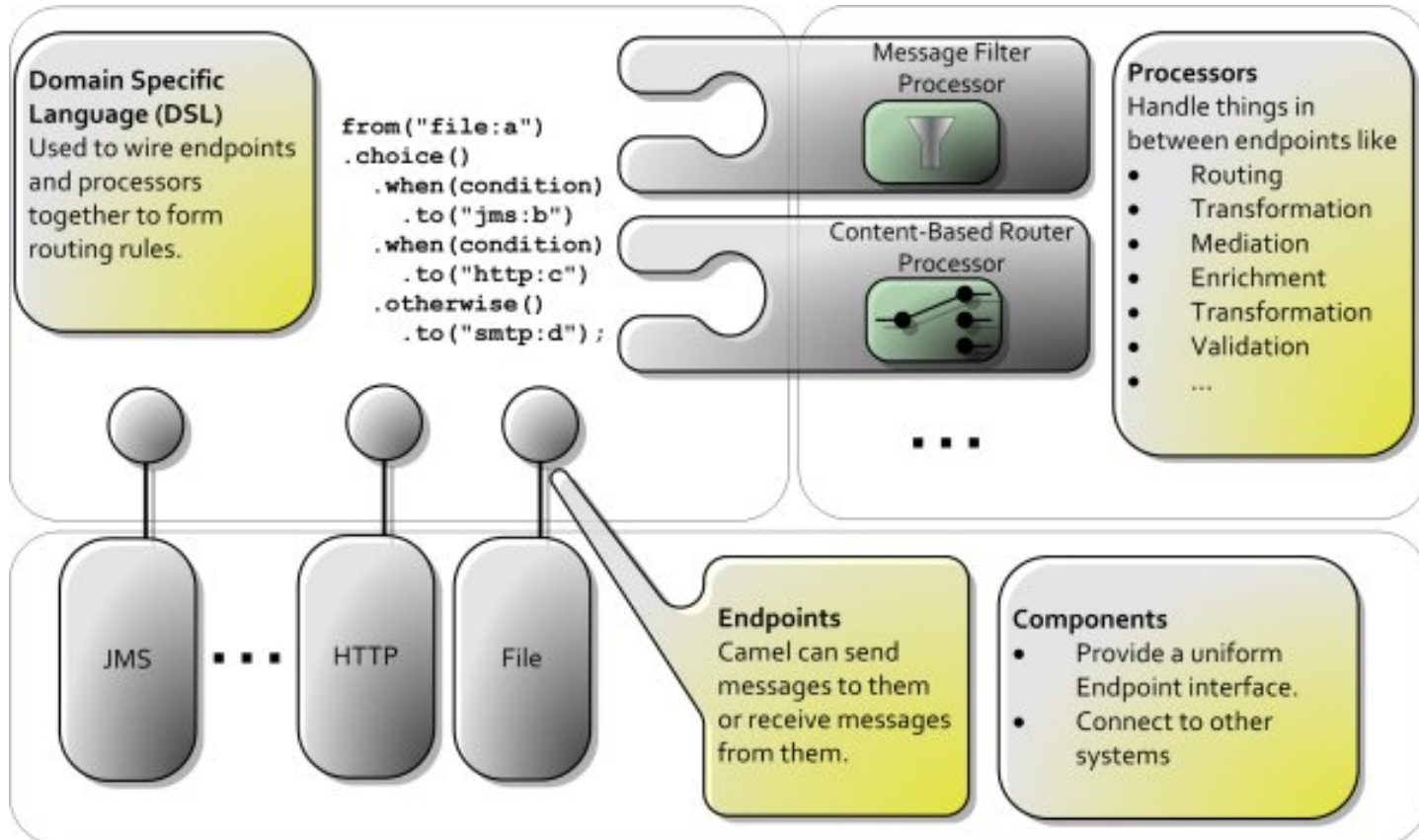





```
from("activemq:queue:order")  
    .choice()  
        .when(header("paytype").isEqualTo("creditcard"))  
            .to("websphere-mq:queue:creditcards")  
        .when(header("paytype").isEqualTo("bankcard"))  
            .to("smtp://mwea.mailserver:30?password=xy&user=kw")  
        .otherwise()  
            .to("websphere-mq:queue:invalidOrder");
```

1) Was sind Enterprise Integration Patterns?

2) Was ist Apache Camel?

3) Anwendungsfall für das Live-Demo

4) LIVE DEMO: Apache Camel

5) Ausblick

Use Case

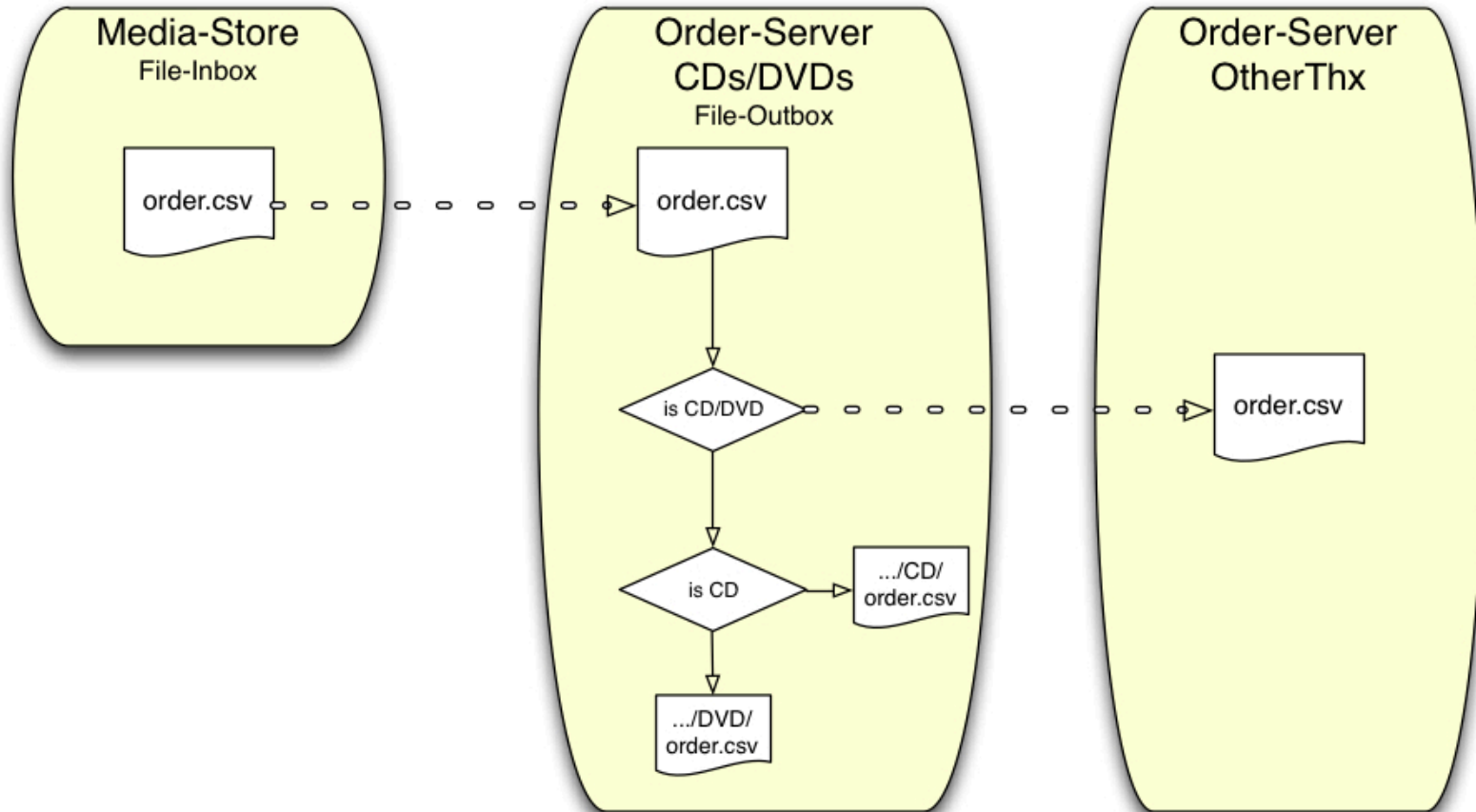

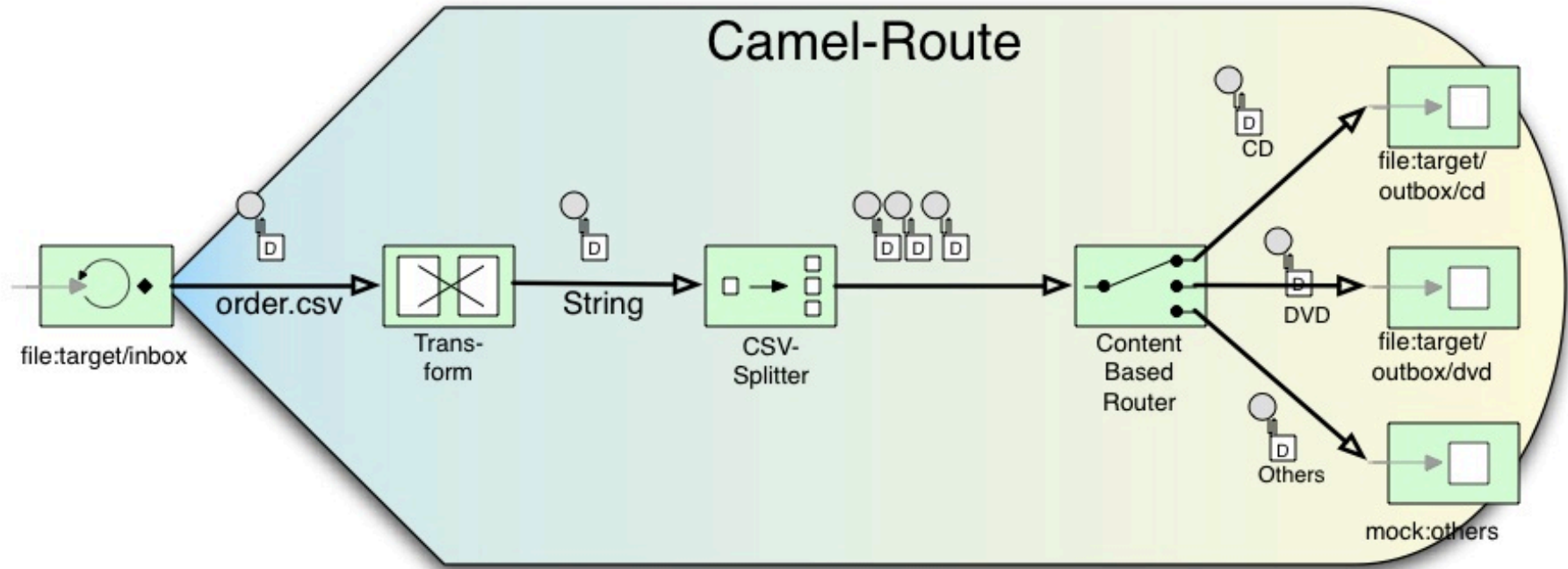

1) Was sind Enterprise Integration Patterns?

2) Was ist Apache Camel?

3) Anwendungsfall für das Live-Demo

**4) LIVE DEMO: Apache Camel**

5) Ausblick

# Genug Theorie!

## ⇒ Auf zum Live Demo...

1) Was sind Enterprise Integration Patterns?

2) Was ist Apache Camel?

3) Anwendungsfall für das Live-Demo

4) LIVE DEMO: Apache Camel

5) Ausblick





SQL TCP SMTP Jetty JMS  
Netty  
RMI FTP Lucene JDBC EJB  
Bean-Validation MQ GAE  
JMX  
RSS AMQP Quartz  
AWS Atom Log  
File HTTP Akka LDAP XSLT  
CXF

Viele viele mehr... Eigene Komponenten...

Standalone

Application Server

Web Container

OSGi

Spring Container

Cloud







# Fuse IDE

VS.

# Talend Integration Suite



Stabiles Produkt

Vice versa Development

Simple, intuitives Eclipse-Plugin

Proprietär

Kostenpflichtig

# Fuse IDE

vs.

# Talend Integration Suite

Open Source

Viel generierter Code

Keine manuelle Routen-Bearbeitung

Lizenz-Dschungel

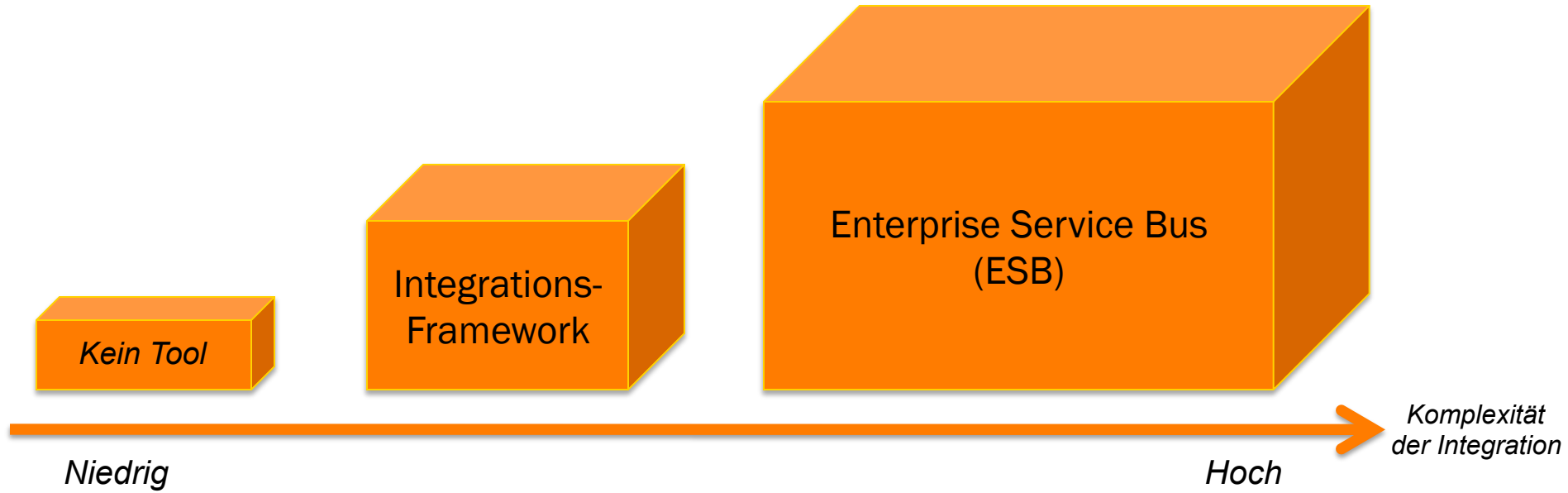

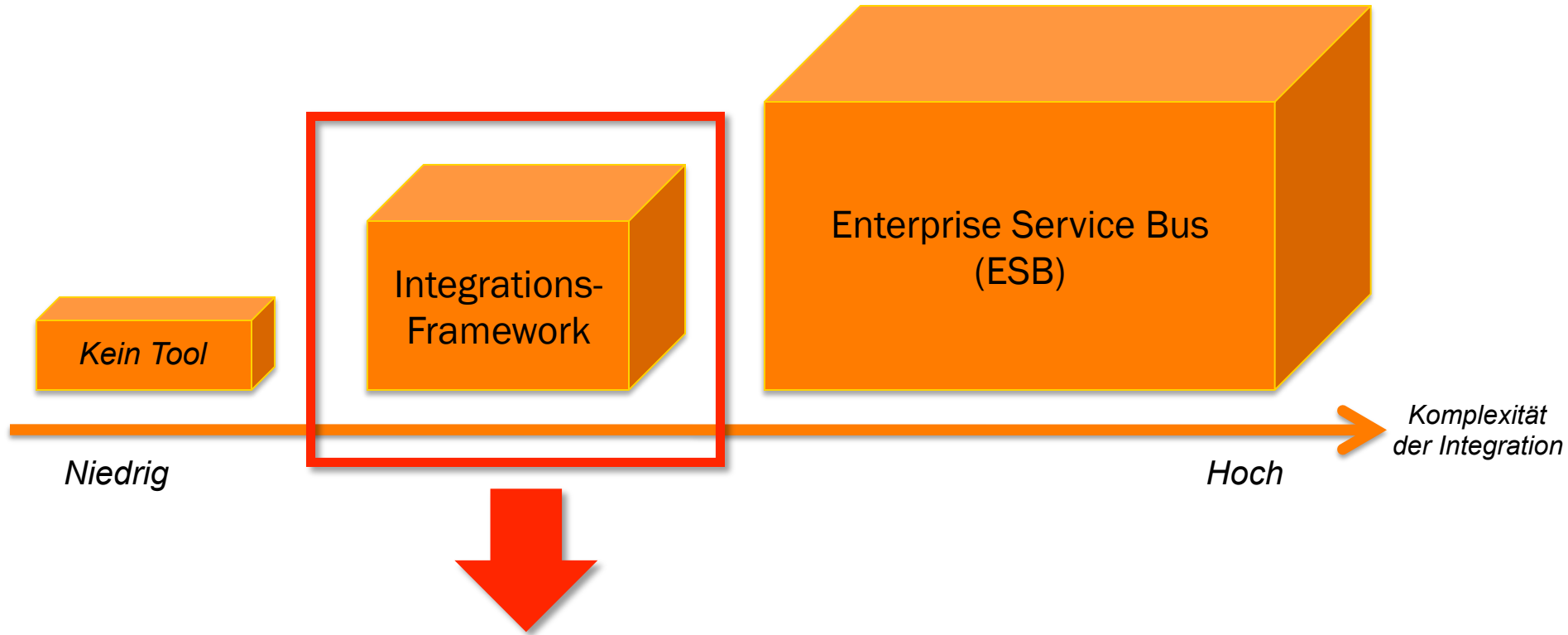

# Apache Camel vs. Spring Integration

# ... der Systemintegrator!





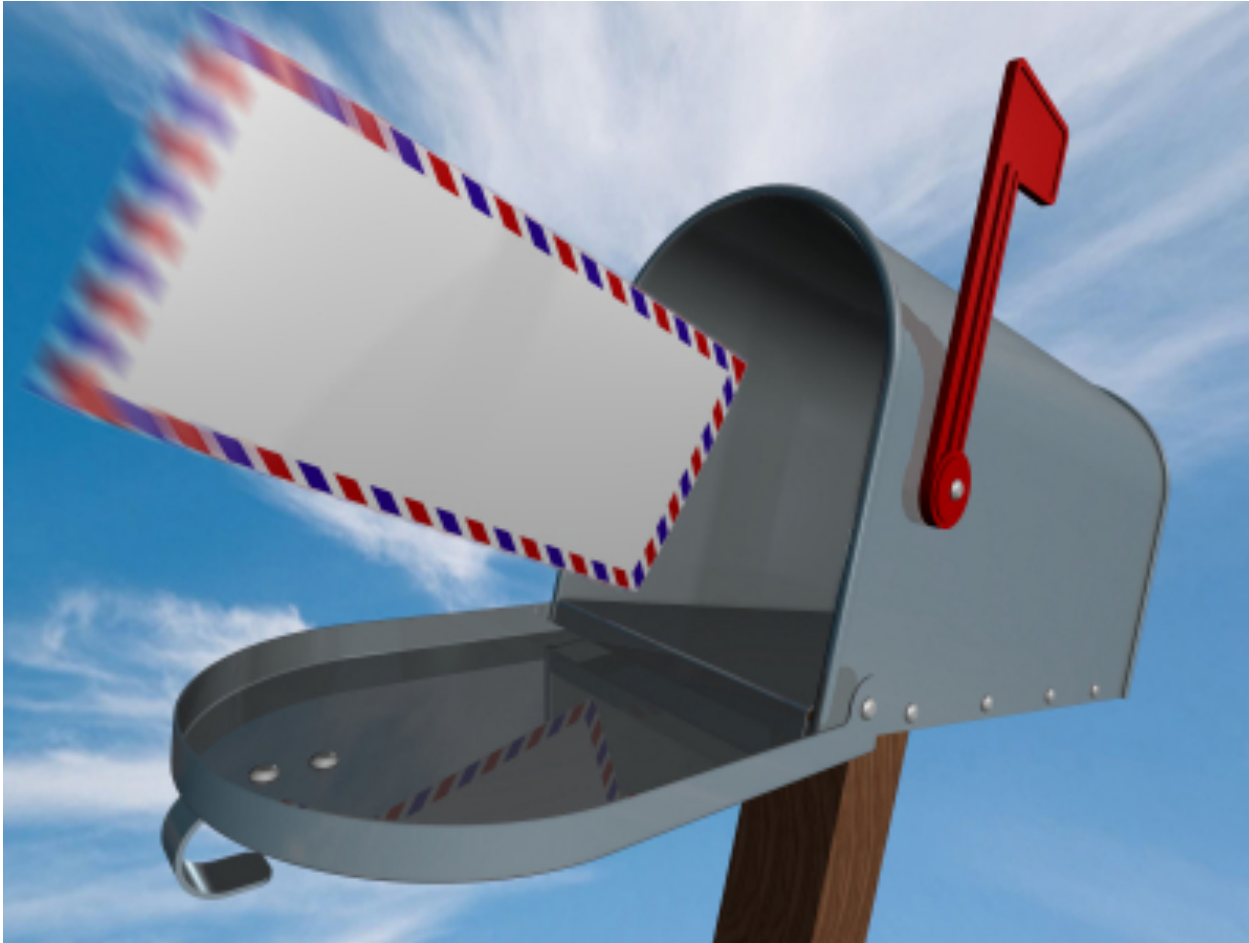

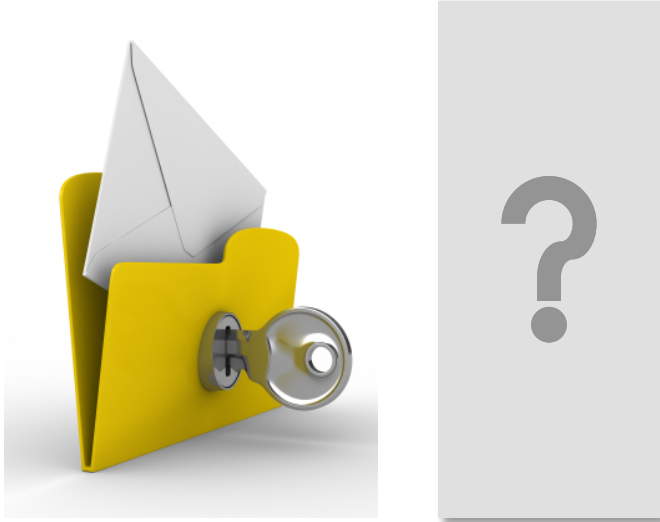

Enterprise Integration Patterns verstehen!

Das Konzept von Apache Camel verstehen!

Apache Camel an Hand des Live-Demos kennenlernen!

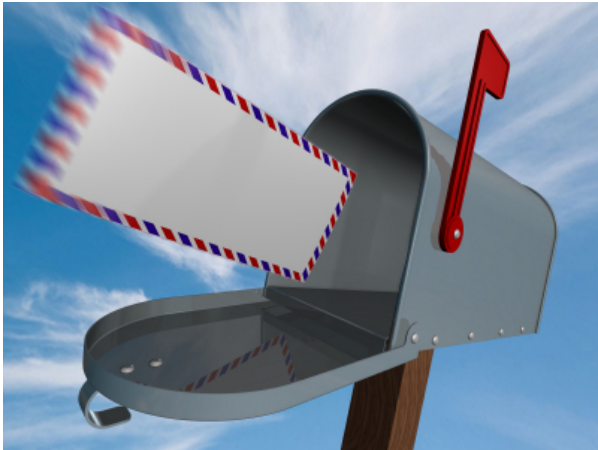

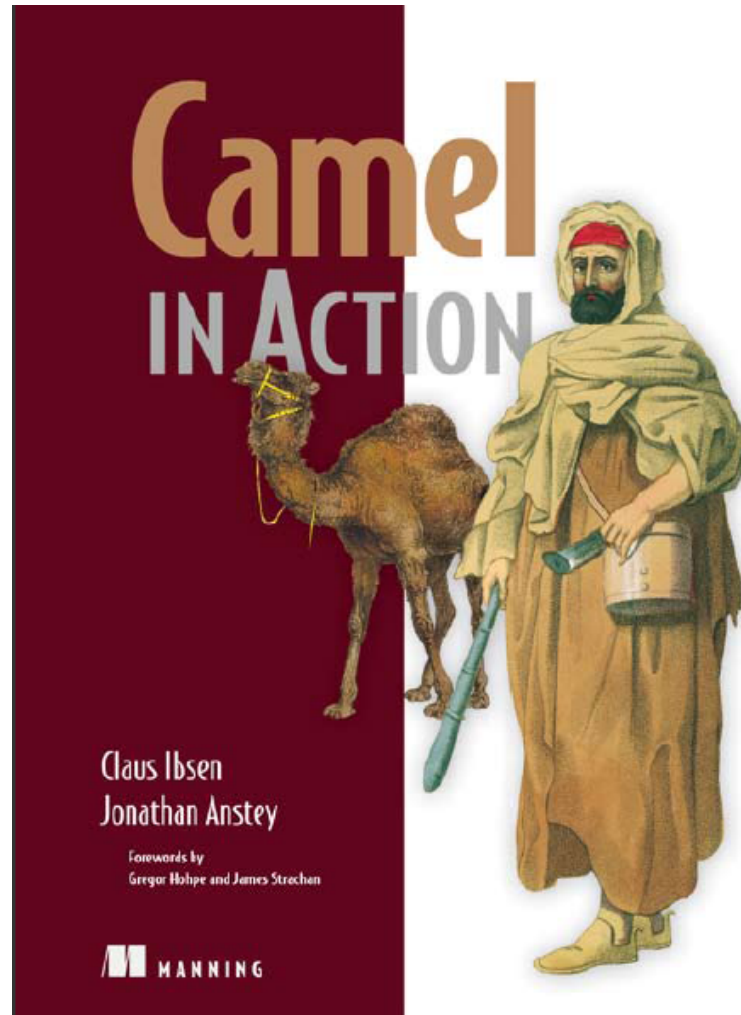



- Dashboards
- Projects
- Issues
- Agile





## Camel

- Summary
- Issues
- Road Map**
- Agile
- Change Log
- Popular Issues
- Subversion Commits
- Versions
- Components
- Labels
- Source

### Road Map

A list of upcoming versions. Click on the row to display issues for that version.

- ▶  **2.7.1**  
[Release Notes](#)
- ▶  **2.8.0**  
[Release Notes](#)
- ▶  **3.0.0**  
[Release Notes](#)
- ▶  **Future**  
[Release Notes](#)

Future

5.– 8. September 2011  
in Nürnberg



# Herbstcampus

Wissenstransfer  
par excellence

**Vielen Dank für Ihre Aufmerksamkeit!**

**Kai Wähler**

MaibornWolff et al GmbH

Email: [kai.waehner@mwea.de](mailto:kai.waehner@mwea.de)

Twitter: [@KaiWaehner](https://twitter.com/KaiWaehner)

**Martin Huber**

innoQ GmbH

Email: [martin.huber@innoq.com](mailto:martin.huber@innoq.com)

Twitter: [@Waterback](https://twitter.com/Waterback)